

7/1

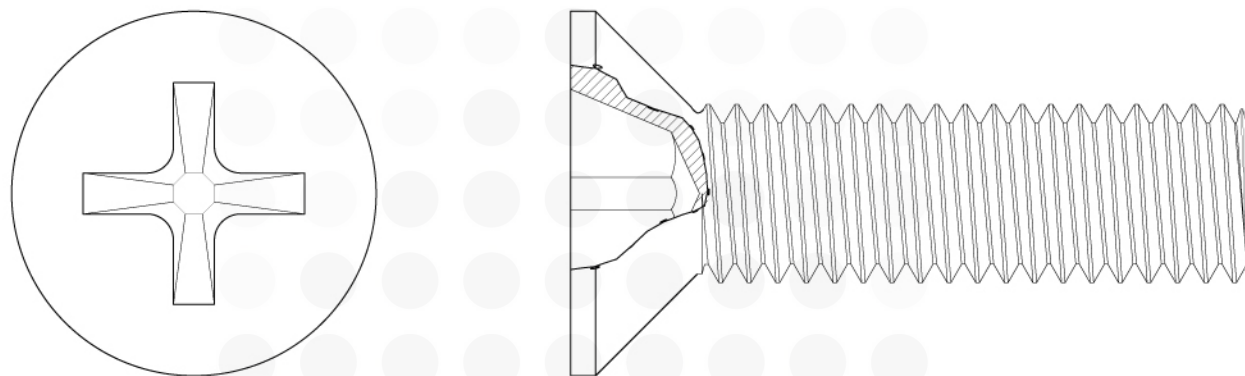

PHILLIPS RECESS COUNTERSUNK
FLAT HEAD MACHINE SCREWS

THAI UNION®
FASTENERS

7/2

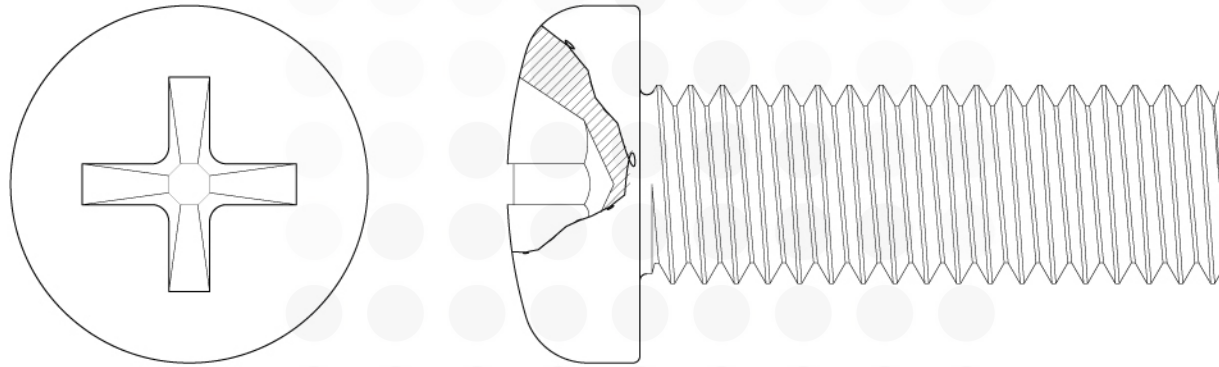

PHILLIPS RECESS PAN HEAD
MACHINE SCREWS

THAT UNION®
FASTENERS

7/3

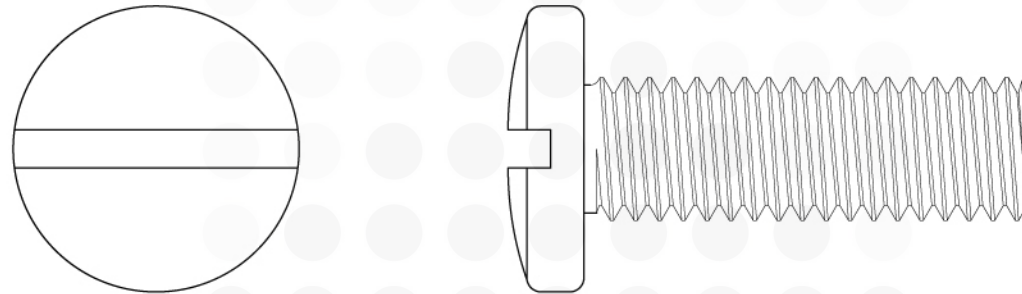

SLOTTED RECESS PAN HEAD
MACHINE SCREWS

THAI UNION®
FASTENERS

7/4

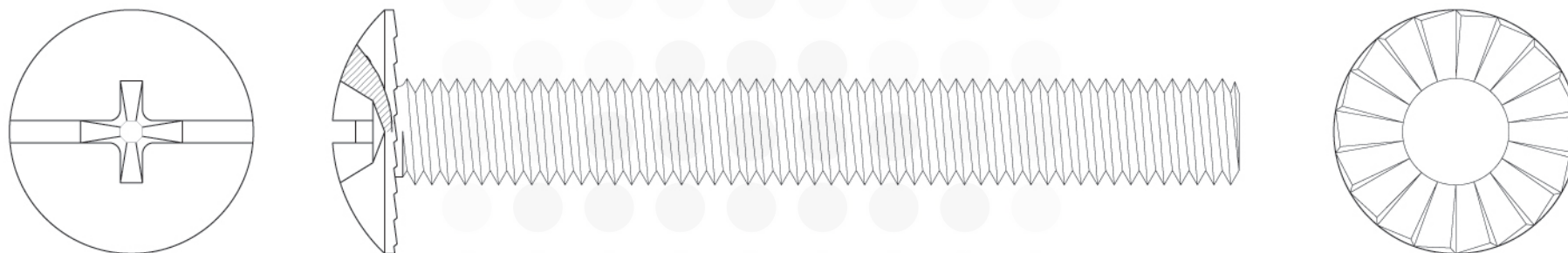

PHILLIPS & SLOT COMBINATION RECESS
TRUSS HEAD (WITH 18 SERRATIONS)
MACHINE SCREWS

THE UNION®
FASTENERS

7/5

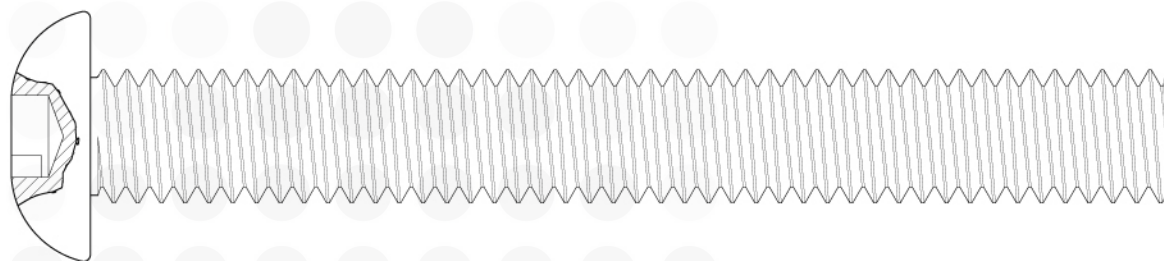
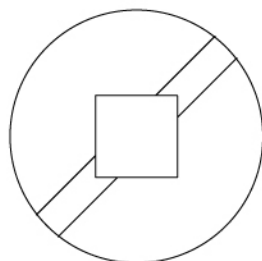

SQUARE & SLOT COMBINATION RECESS
ROUND HEAD MACHINE SCREWS

THAI UNION®
FASTENERS

7/6

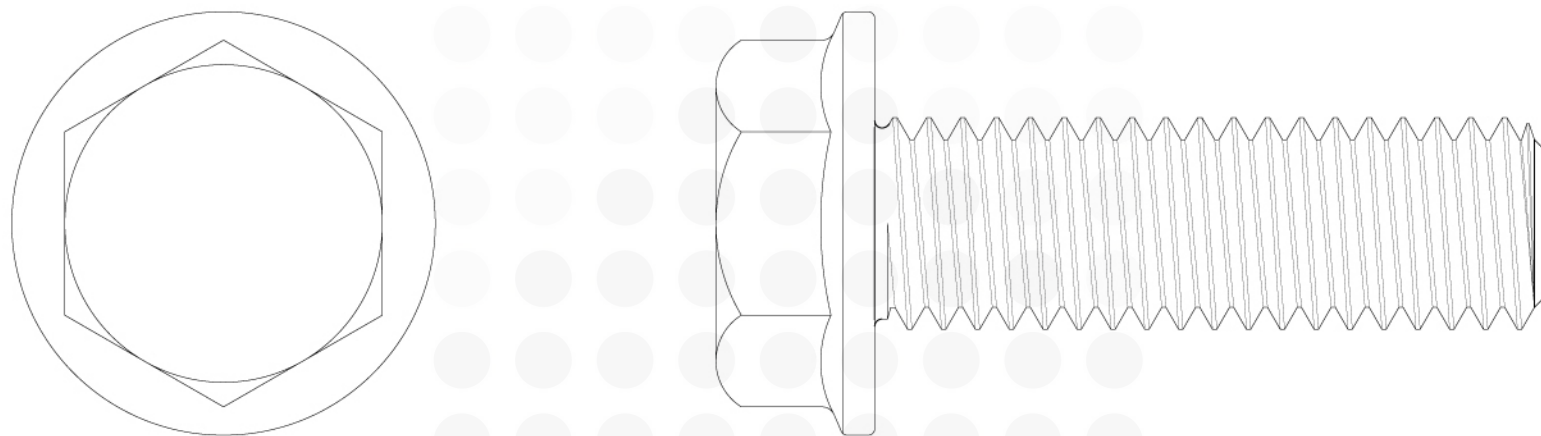

UNSLOTTED INDENTED HEXAGON WITH
PRESSED WASHER HEAD MACHINE SCREWS

THAI UNION[®]
FASTENERS