

2/1

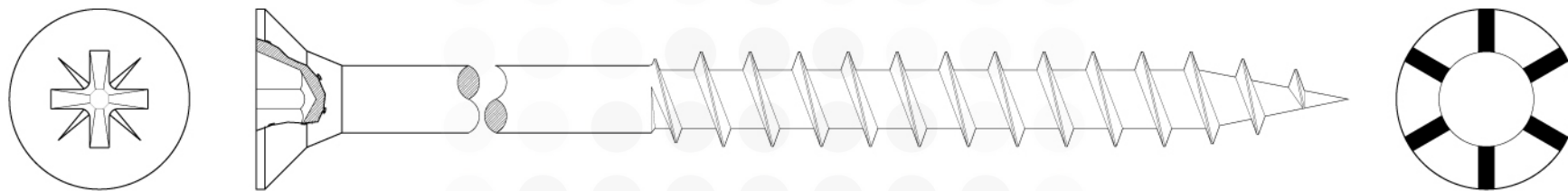

POZI RECESS COUNTERSUNK FLAT HEAD  
CHIPBOARD SCREWS WITH 6 NIBS UNDER HEAD

THAI UNION®  
FASTENERS

2/2

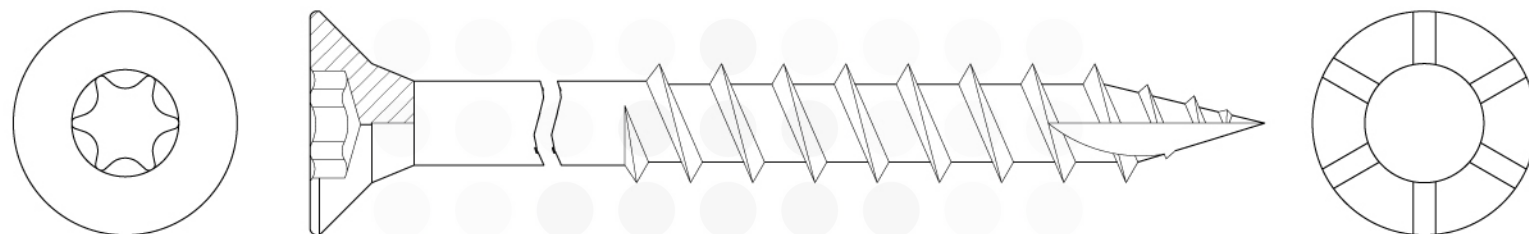

TORX RECESS COUNTERSUNK FLAT  
HEAD CHIPBOARD SCREWS ( WITH 6  
NIBS UNDER HEAD POINT CUTTING)  
(TYPE 17)

THAI UNION<sup>®</sup>  
FASTENERS

2/3

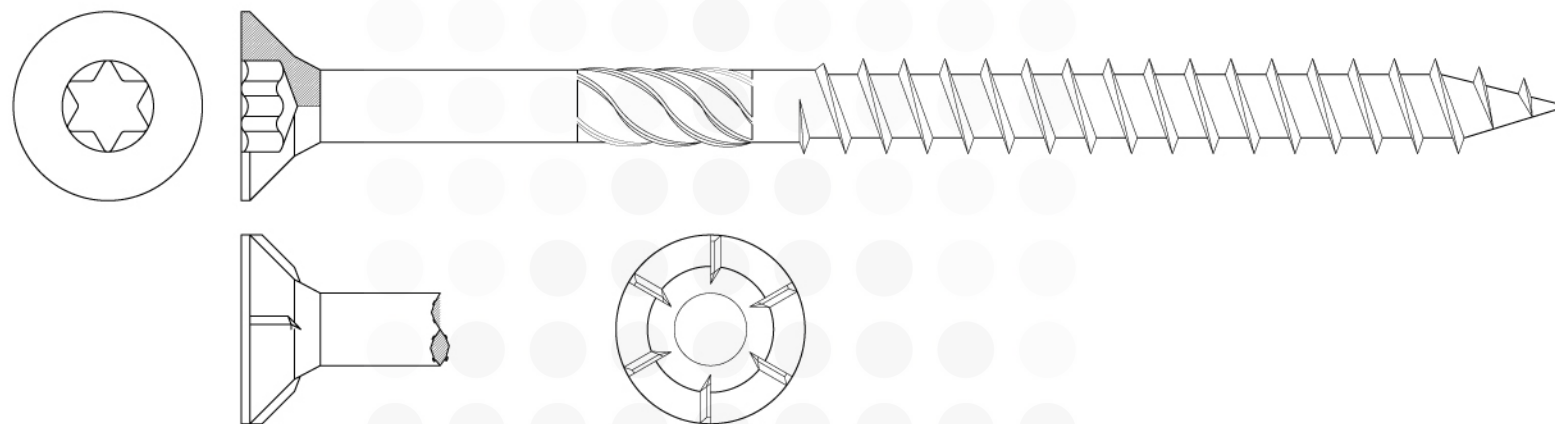

TORX RECESS COUNTERSUNK FLAT  
HEAD WITH 6 NIBS UNDER HEAD  
TWIN THREAD AND PARTIAL THREAD  
WITH SERRATION HEAD

2/4

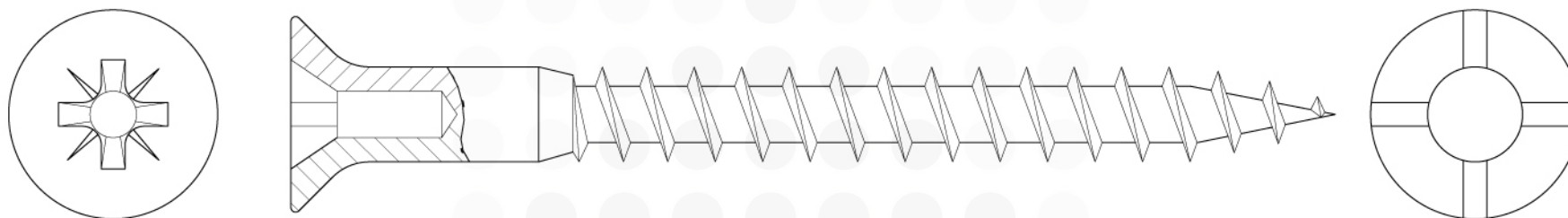

POZI (WITH HOLE) COUNTERSUNK FLAT  
HEAD WITH 4 SERRATIONS CHIPBOARD  
SCREWS

THAI UNION®  
FASTENERS

2/5

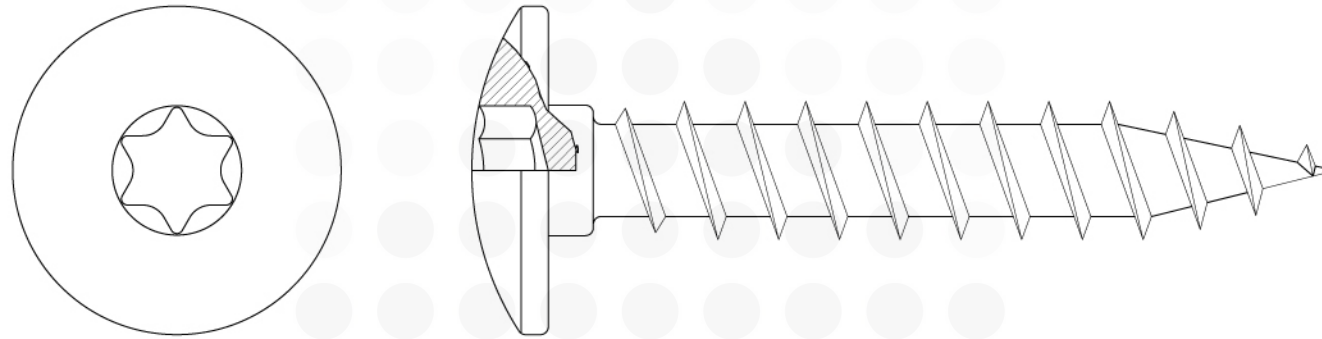

TORX RECESS TRUSS HEAD  
CHIPBOARD SCREWS

THAT UNION®  
FASTENERS

2/6

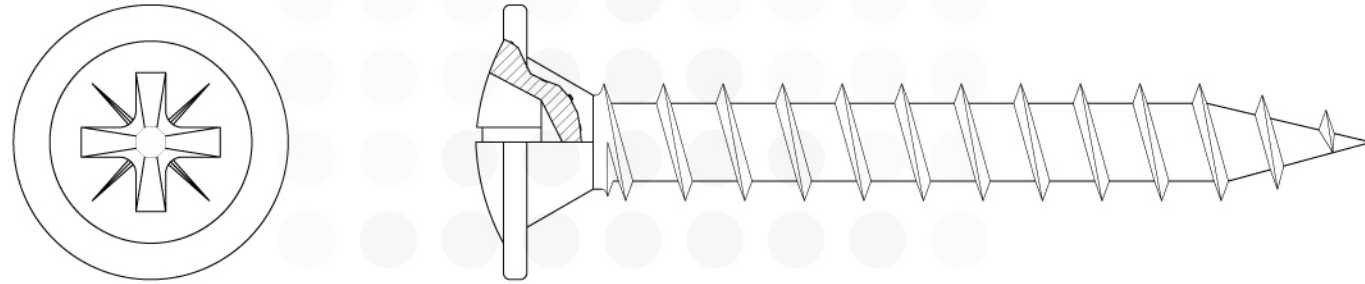

POZI RECESS BACKWALL SCREWS

THAI UNION®  
FASTENERS

2/7

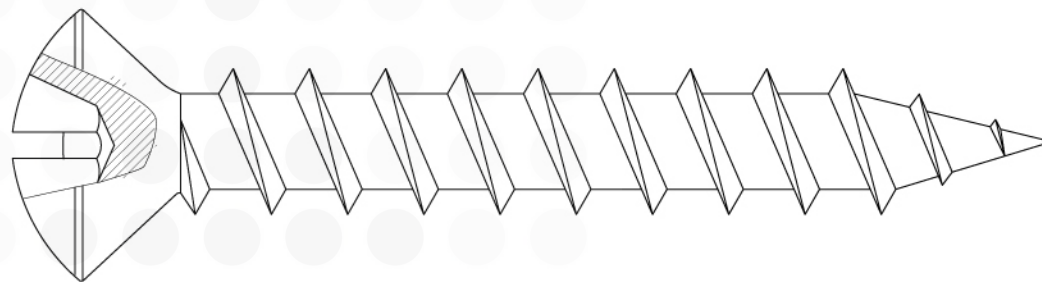
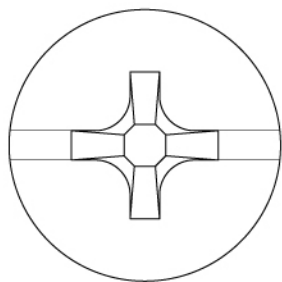

PHILLIPS & SLOTTED COMBINATION  
RECESS COUNTERSUNK OVAL HEAD  
CHIPBOARD SCREWS

THAT UNION®  
FASTENERS